

FOR INDOOR USE!

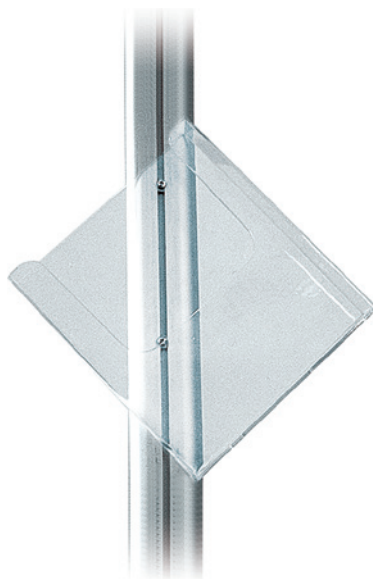

4 x A4
brochure
holders

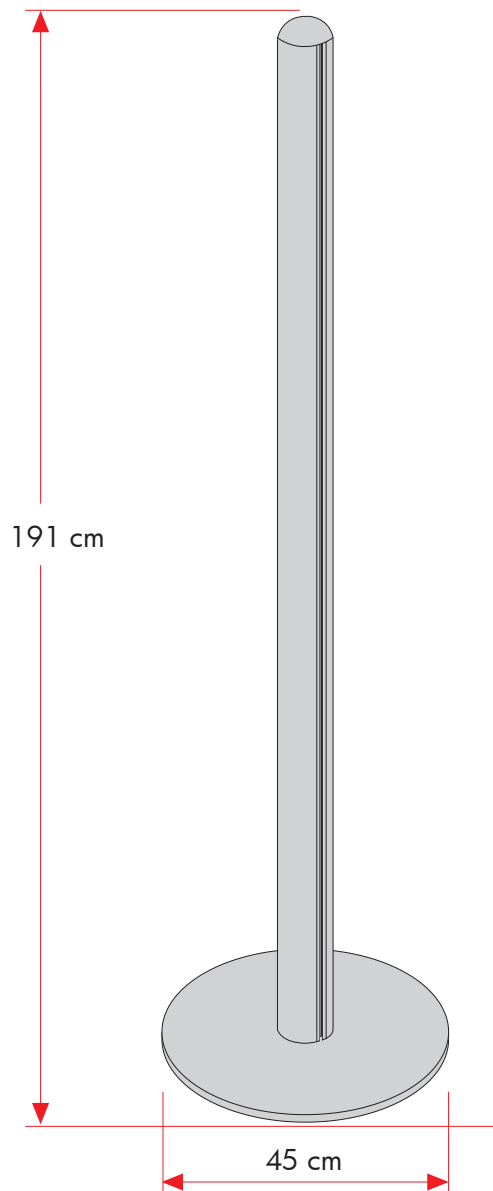

🇬🇧 Anodized aluminum stand with 4 pcs. slanting A4 polycarbonate brochure holders. For indoor use.

🇩🇪 Eloxiertes Aluminium Ständer mit 4 Stück A4 Prospekthalter, schräg, aus Polycarbonat hergestellt. Für den Innenbereich.

🇩🇰 Eloxeret aluminiumsstander med 4 stk. skrå A4 polycarbonat brochureholdere. Til indendørs brug.

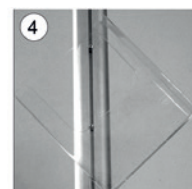
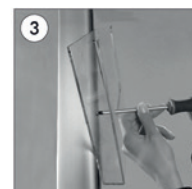
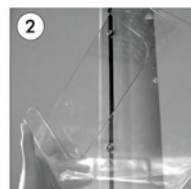
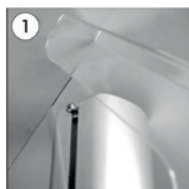
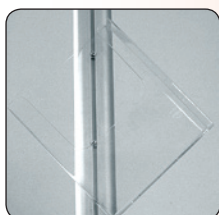
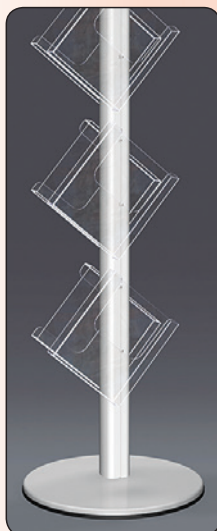
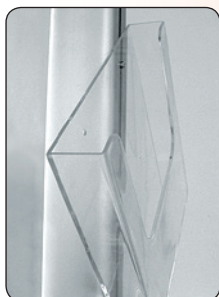

•Slide the connectors of the transparent shelves through the pole channel.
•Mutter on der transparenten Ablage in de Kanal am Mast durchstecken

•Place the transparent shelf on desired position by fixing the connectors.
•An der Wunschhöhe durch Schrauben an den Ablage fest ziehen.



Model	Art. no.	Capacity	Colour	Total W x H	Base	Weight	Pallet size and quantity
921	2875	4 x A4	Alu / Acrylic	45 x 190 cm	Ø 45 cm	19 kg	80 x 120 x 220 cm 20 pcs.